

# CUTTING TOOLS

# THREADING TOOLS

## WIRE THREAD INSERT

Type "Free running"

P.498-500

## THREAD REPAIR KITS

M

P.501-502

BSW

P.503

## THREAD REPAIR WORKSHOP KITS

KITS

P.504-507

For Spark plug

P.508

PRO

P.509

## THREADING TOOLS

AL+SP / AL-SP

P.510

AL-PO

P.511

AL-HT

P.511-513

N+RS / N-RS

P.513-514

N-CT LA

P.514

B30

P.515-516

## INSTALLATION TOOLS

Inserting Tools

P.517-518

Tang Break Tools

P.519

Extracting

P.520

JSR GROUP

# WIRE THREAD INSERT

สปริงเสริมเกลียว



สปริงเสริมเกลียว

Wire Thread Insert - type: "free running" - material: stainless steel 304

DIN 8140 Tolerance ISO 2 (6H)



## M

Diameter x Pitch	pack. unit	1.0 D 1.0 x Diameter	1.5 D 1.5 x Diameter	2.0 D 2.0 x Diameter	2.5 D 2.5 x Diameter	3.0 D 3.0 x Diameter
		Item-No.:	Item-No.:	Item-No.:	Item-No.:	Item-No.:
M 2x0.4	100	1-B7202-1	1-B7202-15	1-B7202-2	1-B7202-25	1-B7202-3
	10	2-B7202-1	2-B7202-15	2-B7202-2	2-B7202-25	2-B7202-3
M 2.2x0.45	100	1-B7203-1	1-B7203-15	1-B7203-2	1-B7203-25	1-B7203-3
M 2.5x0.45	100	1-B7204-1	1-B7204-15	1-B7204-2	1-B7204-25	1-B7204-3
	10	2-B7204-1	2-B7204-15	2-B7204-2	-	-
M 3x0.5	100	1-B7205-1	1-B7205-15	1-B7205-2	1-B7205-25	1-B7205-3
	10	2-B7205-1	2-B7205-15	2-B7205-2	2-B7205-25	2-B7205-3
M 3.5x0.6	100	1-B7206-1	1-B7206-15	1-B7206-2	1-B7206-25	1-B7206-3
M 4x0.7	100	1-B7207-1	1-B7207-15	1-B7207-2	1-B7207-25	1-B7207-3
	10	2-B7207-1	2-B7207-15	2-B7207-2	2-B7207-25	2-B7207-3
M 4.5x0.75	100	1-BE4575-1	1-BE4575-15	1-BE4575-2	1-BE4575-25	1-BE4575-3
M 5x0.8	100	1-B7208-1	1-B7208-15	1-B7208-2	1-B7208-25	1-B7208-3
	10	2-B7208-1	2-B7208-15	2-B7208-2	2-B7208-25	2-B7208-3
M 6x0.75	100	1-BE675-1	1-BE675-15	1-BE675-2	-	-
M 6x1.0	100	1-B7209-1	1-B7209-15	1-B7209-2	1-B7209-25	1-B7209-3
	10	2-B7209-1	2-B7209-15	2-B7209-2	2-B7209-25	2-B7209-3
M 7x1.0	100	1-B7210-1	1-B7210-15	1-B7210-2	1-B7210-25	1-B7210-3
	10	2-B7210-1	2-B7210-15	2-B7210-2	2-B7210-25	2-B7210-3
M 8x0.75	100	1-BE875-1	1-BE875-15	1-BE875-2	-	-
M 8x1.0	100	1-B7212-1	1-B7212-15	1-B7212-2	1-B7212-25	1-B7212-3
	10	2-B7212-1	2-B7212-15	2-B7212-2	2-B7212-25	2-B7212-3
M 8x1.25	100	1-B7211-1	1-B7211-15	1-B7211-2	1-B7211-25	1-B7211-3
	10	2-B7211-1	2-B7211-15	2-B7211-2	2-B7211-25	2-B7211-3
M 9x1.0	100	1-BE91-1	1-BE91-15	1-BE91-2	-	-
	10	-	1-BE91-15	-	-	-
M 9x1.25	100	1-B7213-1	1-B7213-15	1-B7213-2	1-B7213-25	1-B7213-3
	10	2-B7213-1	2-B7213-15	2-B7213-2	2-B7213-25	2-B7213-3
M 10x1.0	100	1-B7217-1	1-B7217-15	1-B7217-2	1-B7217-25	1-B7217-3
	10	2-B7217-1	2-B7217-15	2-B7217-2	2-B7217-25	2-B7217-3
M 10x1.25	100	1-B7216-1	1-B7216-15	1-B7216-2	1-B7216-25	1-B7216-3
	10	2-B7216-1	2-B7216-15	2-B7216-2	2-B7216-25	2-B7216-3
M 10x1.5	100	1-B7215-1	1-B7215-15	1-B7215-2	1-B7215-25	1-B7215-3
	10	2-B7215-1	2-B7215-15	2-B7215-2	2-B7215-25	2-B7215-3
M 11x1.0	100	1-BE111-1	1-BE111-15	1-BE111-2	-	-
M 11x1.25	100	-	1-BE1125-15	1-BE1125-2	-	-
	10	-	2-BE1128-15	-	-	-
M 11x1.5	100	1-B7219-1	1-B7219-15	1-B7219-2	1-B7219-25	1-B7219-3
	10	2-B7219-1	2-B7219-15	2-B7219-2	2-B7219-25	-
M 12x1.0	100	1-B7224-1	1-B7224-15	1-B7224-2	1-B7224-25	1-B7224-3
	10	2-B7224-1	2-B7224-15	2-B7224-2	2-B7224-25	-
M 12x1.25	100	1-B7223-1	1-B7223-15	1-B7223-2	1-B7223-25	1-B7223-3
	10	2-B7223-1	2-B7223-15	2-B7223-2	2-B7223-25	2-B7223-3
M 12x1.5	100	1-B7222-1	1-B7222-15	1-B7222-2	1-B7222-25	1-B7222-3
	10	2-B7222-1	2-B7222-15	2-B7222-2	2-B7222-25	2-B7222-3
M 12x1.75	100	1-B7221-1	1-B7221-15	1-B7221-2	1-B7221-25	1-B7221-3
	10	2-B7221-1	2-B7221-15	2-B7221-2	2-B7221-25	2-B7221-3
M 13x1.25	50	1-BE1325-1	1-BE1325-15	1-BE1325-2	-	-
M 13x1.5	50	1-BE1315-1	1-BE1315-15	1-BE1315-2	-	-
M 14x1.0	50	1-B7228-1	1-B7228-15	1-B7228-2	1-B7228-25	1-B7228-3
	10	2-B7228-1	2-B7228-15	2-B7228-2	2-B7228-25	2-B7228-3
M 14x1.25	50	1-B7227-1	1-B7227-15	1-B7227-2	1-B7227-25	1-B7227-3
	10	2-B7227-1	2-B7227-15	2-B7227-2	2-B7227-25	2-B7227-3
M 14x1.5	50	1-B7226-1	1-B7226-15	1-B7226-2	1-B7226-25	1-B7226-3
	10	2-B7226-1	2-B7226-15	2-B7226-2	2-B7226-25	2-B7226-3
M 14x2.0	50	1-B7225-1	1-B7225-15	1-B7225-2	1-B7225-25	1-B7225-3
	10	2-B7225-1	1-B7225-15	2-B7225-2	2-B7225-25	2-B7225-3

# WIRE THREAD INSERT

สปริงเสริมเกลียว



WIRE THREAD INSERT  
สปริงเสริมเกลียว



**1.0 D**  
1.0 x Diameter



**1.5 D**  
1.5 x Diameter



**2.0 D**  
2.0 x Diameter



**2.5 D**  
2.5 x Diameter



**3.0 D**  
3.0 x Diameter

## M

Diameter x Pitch	pack. unit	Item-No.:	Item-No.:	Item-No.:	Item-No.:	Item-No.:
M 15x1.5	50	1-BE1515-1	1-BE1515-15	1-BE1515-2		
M16x1.5	50	1-B7235-1	1-B7235-15	1-B7235-2	1-B7235-25	1-B7235-3
	10	2-B7235-1	2-B7235-15	2-B7235-2	2-B7235-25	2-B7235-3
M16x2.0	50	1-B7234-1	1-B7234-15	1-B7234-2	1-B7234-25	1-B7234-3
	10	2-B7234-1	2-B7234-15	2-B7234-2	2-B7234-25	2-B7234-3
M18x1.5	25	1-B7238-1	1-B7238-15	1-B7238-2	1-B7238-25	1-B7238-3
M18x2.0	25	1-B7237-1	1-B7237-15	1-B7237-2	1-B7237-25	1-B7237-3
M18x2.5	25	1-B7236-1	1-B7236-15	1-B7236-2	1-B7236-25	1-B7236-3
M20x1.5	25	1-B7241-1	1-B7241-15	1-B7241-2	1-B7241-25	1-B7241-3
M20x2.0	25	1-B7240-1	1-B7240-15	1-B7240-2	1-B7240-25	1-B7240-3
M20x2.5	25	1-B7239-1	1-B7239-15	1-B7239-2	1-B7239-25	1-B7239-3
M22x2.0	25	1-B7243-1	1-B7243-15	1-B7243-2	1-B7243-25	1-B7243-3
M22x1.5	25	1-B7244-1	1-B7244-15	1-B7244-2	1-B7244-25	1-B7244-3
M22x2.0	25	1-B7242-1	1-B7242-15	1-B7242-2	1-B7242-25	1-B7242-3
M24x1.5	25	1-B7247-1	1-B7247-15	1-B7247-2	1-B7247-25	1-B7247-3
M24x2.0	25	1-B7246-1	1-B7246-15	1-B7246-2	1-B7246-25	1-B7246-3
M24x3.0	25	1-B7245-1	1-B7245-15	1-B7245-2	1-B7245-25	1-B7245-3
M26x1.5	5	-	1-B7349-15	-	-	-
M27x1.5	5	-	1-B7352-15	-	-	-
M27x2.0	5	-	1-B7351-15	-	-	-
M27x3.0	5	1-BE273-1	1-BE273-15	1-BE273-2	-	-
M30x1.5	5	1-B7353-1	1-B7353-15	-	-	-
M30x2.0	5	1-B7356-1	1-B7356-15	-	-	-
M30x3.5	5	1-B7355-1	1-B7355-15	-	-	-
M33x1.5	5	1-B7354-1	1-B7354-15	1-B7354-2	-	-
M33x2.0	5	1-B7358-1	1-B7358-15	-	-	-
M33x3.5	5	1-B7357-1	1-B7357-15	1-B7357-2	-	-
M36x1.5	5	-	1-B7363-15	-	-	-
M36x2.0	5	-	1-B7362-15	-	-	-
M36x3.0	5	-	1-B7361-15	-	-	-
M36x4.0	5	1-BE364-1	1-BE364-15	1-BE364-2	-	-
M39x2.0	5	-	1-BE392-15	-	-	-
M39x4.0	5	-	1-BE394-15	-	-	-
M42x2.0	5	-	1-BE422-15	-	-	-
M42x3.0	5	-	1-BE423-15	-	-	-
M42x4.0	5	-	1-BE424-15	-	-	-

### For Spark Plug

Diameter x Pitch	pack. unit	8.4mm Item-No.:	12.4mm Item-No.:	16.4mm Item-No.:
M14x1.25	50	1-B7128	1-B7228	1-B7328
	10	2-B7128	2-B7228	2-B7328
M18x1.5	10	<b>12.7mm</b> 1-B7238-127	<b>15.9mm</b> 1-B7238-159	<b>16.7mm</b> 1-B7238-167

# WIRE THREAD INSERT

สปริงเสริมเกลียว



สปริงเสริมเกลียว

**Wire Thread Insert - type: "free running" - material: stainless steel 304**

BearCoil® Wire Thread Inserts on strip feed are especially used in the bulk production to speed up the inserting process



Wire Thread  
Insert  
สปริงเสริมเกลียว



**1.0 D**  
1.0 x Diameter



**1.5 D**  
1.5 x Diameter



**2.0 D**  
2.0 x Diameter

**M**

Diameter x Pitch	Item-No.:	Item-No.:	Item-No.:
M3x0.5	B7205-1MAG	B7205-15MAG	B7205-2MAG
M4x0.7	B7207-1MAG	B7207-15MAG	B7207-2MAG
M5x0.8	B7208-1MAG	B7208-15MAG	B7208-2MAG
M6x1.0	B7209-1MAG	B7209-15MAG	B7209-2MAG
M8x1.25	B7211-1MAG	B7211-15MAG	B7211-2MAG
M10x1.5	B7215-1MAG	B7215-15MAG	B7215-2MAG

Please inquire prices, quantities and other dimensions.

# THREAD REPAIR KITS

สปริงเสริมเกลียว พร้อมอุปกรณ์



Thread Repair Kits  
สปริงเสริมเกลียว พร้อมอุปกรณ์

## สปริงเสริมเกลียวพร้อมอุปกรณ์ Thread Repair Kits



**M** ISO metric thread

Drill Hss, STI Bottoming Tap HSSG

Inserting Tool

Tang Break Tool

Wire Thread Inserts - type: "free running" - length: 1.5 D

Instruction for use

Thread repair

kits

สปริงเสริมเกลียว  
พร้อมอุปกรณ์

Order No.						1.5D
B4001	M2x0.4	EBW01	BZ001	2.1mm	20	
B4002	M2.2x0.45	EBW01	BZ001	2.3mm	20	
B4003	M2.5x0.45	EBW02	BZ002	2.6mm	20	
B4005	M3x0.5	EBW03	BZ003	3.2mm	20	
B4006	M3.5x0.6	EBW03	BZ003	3.7mm	20	
B4007	M4x0.7	EBW04	BZ004	4.2mm	20	
B4009	M5x0.8	EBW05	BZ005	5.2mm	20	
B0675	M6x0.75	EBW06	BZ006	6.3mm	10	
B4010	M6x1.0	EBW06	BZ006	6.3mm	20	
B4011	M7x1.0	EBW07	BZ006	7.3mm	20	
B0875	M8x0.75	EBW08	BZ008	8.3mm	10	
B4013	M8x1.0	EBW08	BZ008	8.3mm	20	
B4012	M8x1.25	EBW08	BZ008	8.3mm	20	
B0091	M9x1.0	EBW08	BZ008	9.3mm	10	
B4014	M9x1.25	EBW08	BZ008	9.3mm	15	
B4018	M10x1.0	EBW10	BZ010	10.3mm	15	
B4017	M10x1.25	EBW10	BZ010	10.3mm	15	
B4016	M10x1.5	EBW10	BZ010	10.4mm	15	
B0111	M11x1.0	EBW10	BZ010	11.4mm	5	
B1125	M11x1.25	EBW10	BZ010	11.4mm	5	
B4019	M11x1.5	EBW10	BZ010	11.4mm	10	
B4024	M12x1.0	EBW12	BZ012	12.3mm	10	
B4023	M12x1.25	EBW12	BZ012	12.3mm	10	
B4022	M12x1.5	EBW12	BZ012	12.4mm	10	
B4021	M12x1.75	EBW12	BZ012	12.4mm	10	
B1315	M13x1.25	EBW12		13.25mm	5	
B1325	M13x1.5	EBW12		13.25mm	5	
B4031	M14x1.0	EBW14		14.4mm	10	
B4030	M14x1.25	EBW14		14.4mm	10	
B4029	M14x1.5	EBW14		14.4mm	10	
B4028	M14x2.0	EBW14		14.5mm	10	
B1515	M15x1.5	EBW14			5	
B1520	M15x2.0	EBW14			5	
B4033	M16x1.5	EBW14			10	
B4032	M16x2.0	EBW14			10	



For sizes bigger than M13 use a long nose pliers to remove the tang.

# THREAD REPAIR KITS

สปริงเสริมเกลียว พร้อมอุปกรณ์



## สปริงเสริมเกลียวพร้อมอุปกรณ์ Thread Repair Kits



Order No.			 1.5D
B4036	M18x1.5	EBW18	5
B4035	M18x2.0	EBW18	5
B4034	M18x2.5	EBW18	5
B4039	M20x1.5	EBW20	5
B4038	M20x2.0	EBW20	5
B4037	M20x2.5	EBW20	5
B4042	M22x1.5	EBW22	5
B4041	M22x2.0	EBW22	5
B4040	M22x2.5	EBW22	5
B4045	M24x1.5	EBW24	5
B4044	M24x2.0	EBW24	5
B4043	M24x3.0	EBW24	5
B4046	M30x3.5	EBW30	5
B0392	M39x2.0	EBW39	5
B0394	M39x4.0	EBW39	5
B0422	M42x2.0	EBW42	5
B0423	M42x3.0	EBW42	5
B0424	M42x4.0	EBW42	5



**M** ISO metric thread

STI Bottoming Tap HSSG  
Inserting Tool  
Wire Thread Inserts - type: "free running" - length: 1.5 D  
Instruction for use

## สปริงเสริมเกลียวพร้อมอุปกรณ์ Thread Repair Kits

Order No.			 1.5D
B4049	M26x1.5	EBW26	5
B4052	M27x1.5	EBW27	5
B4051	M27x2.0	EBW27	5
B4050	M27x3.0	EBW27	5
B4053	M28x1.5	EBW28	5
B4056	M30x1.5	EBW30	5
B4055	M30x2.0	EBW30	5
B4054	M30x3.5	EBW30	5
B4058	M33x2.0	EBW33	5
B4057	M33x3.5	EBW33	5
B4063	M36x1.5	EBW36	5
B4062	M36x2.0	EBW36	5
B4061	M36x3.0	EBW36	5
B0364	M36x4.0	EBW36	5



**M** ISO metric thread

STI Bottoming Tap HSSG  
Inserting Tool  
Wire Thread Inserts - type: "free running" - length: 1.5 D  
Instruction for use

# THREAD REPAIR KITS

สปริงเสริมเกลียว พร้อมอุปกรณ์



Thread Repair Kits  
สปริงเสริมเกลียว พร้อมอุปกรณ์

## สปริงเสริมเกลียวพร้อมอุปกรณ์ Thread Repair Kits



### BSW British standard Whitworth Coarse Thread Series BS 84

Drill Hss  
STI Bottoming Tap HSSG  
Inserting Tool  
Tang Break Tool  
Wire Thread Inserts - type: "free running" - length: 1.5 D  
Instruction for use

### Thread repair kits

สปริงเสริมเกลียว พร้อมอุปกรณ์

Order No.					 1.5D
B4141	BSW 1/8x40	EBW03	BZ003	3.4mm	20
B4142	BSW 3/16x24	EBW05	BZ005	5.0mm	20
B4143	BSW 1/4x20	EBW06	BZ006	6.7mm	20
B4144	BSW 5/16x18	EBW07	BZ006	8.3mm	20
B4145	BSW 3/8x16	EBW08	BZ008	9.9mm	15
B4146	BSW 7/16x14	EBW10	BZ010	11.6mm	10
B4147	BSW 1/2x12	EBW12	BZ012	13.0mm	10
B4148	BSW 9/16x12	EBW14			5
B4149	BSW 5/8x11	EBW14			5
B4153	BSW 11/16x11	EBW16			5
B4150	BSW 3/4x10	EBW18			5
B4151	BSW 7/8x9	EBW22			5
B4152	BSW 1"x8	EBW24			4

## สปริงเสริมเกลียวพร้อมอุปกรณ์ Thread Repair Kits



### BSW British standard Whitworth Coarse Thread Series BS 84

STI - Tap, set of 2 pcs. HSSG  
Inserting Tool  
Wire Thread Inserts - type: "free running" - length: 1.5 D  
Instruction for use

Order No.				 1.5D
B4154	BSW 1.1/8x7	EBW26		5
B4155	BSW 1.1/4x7	EBW30		5
B4156	BSW 1.3/8x6	EBW31		5
B4157	BSW 1.1/2x6	EBW36		5

# THREAD REPAIR KITS

สปริงเสริมเกลียว พร้อมอุปกรณ์



ชุดซ่อมเกลียว

Thread Repair Workshop Kits



Drill HSS  
STI Bottoming Tap HSSE  
Inserting Tool  
Tang Break Tool  
Wire Thread Inserts - type: "free running" - length: 1.5 D - 2.5 D  
Instruction for use

Thread Repair Kits  
สปริงเสริมเกลียว พร้อมอุปกรณ์

Thread repair kits  
สปริงเสริมเกลียว พร้อมอุปกรณ์

## M3-M12

Order No.						
<b>B5101</b>	M 3x0.5	EBW03	BZ003	3.2mm	10	5
	M 4x0.7	EBW04	BZ004	4.2mm	10	5
	M 5x0.8	EBW05	BZ005	5.2mm	10	5
	M 6x1.0	EBW06	BZ006	6.3mm	10	5
	M 8x1.25	EBW08	BZ008	8.3mm	10	5
	M 10x1.5	EBW10	BZ010	10.4mm	5	5
	M 12x1.75	EBW12	BZ012	12.4mm	5	5

## M5-M12

Order No.						
<b>B5104</b>	M 5x0.8	EBW05	BZ005	5.2mm	10	5
	M 6x1.0	EBW06	BZ006	6.3mm	10	5
	M 8x1.25	EBW08	BZ008	8.3mm	10	5
	M 10x1.5	EBW10	BZ010	10.4mm	5	5
	M 12x1.75	EBW12	BZ012	12.4mm	5	5

## M5-M8

Order No.						
<b>B5131</b>	M 5x0.8	EBW05	BZ005	5.2mm	10	5
	M 6x1.0	EBW06	BZ006	6.3mm	10	5
	M 8x1.25	EBW08	BZ008	8.3mm	10	5

## M6-M10

Order No.						
<b>B5130</b>	M 6x1.0	EBW06	BZ006	6.3mm	10	5
	M 8x1.25	EBW08	BZ008	8.3mm	10	5
	M 10x1.5	EBW10	BZ010	10.4mm	5	5

# THREAD REPAIR KITS

สปริงเสริมเกลียว พร้อมอุปกรณ์



Thread Repair Kits  
สปริงเสริมเกลียว พร้อมอุปกรณ์

ชุดซ่อมเกลียว

## Thread Repair Workshop Kits



Drill HSS  
STI Bottoming Tap HSSG  
Inserting Tool  
Tang Break Tool  
Wire Thread Inserts - type: "free running"  
different lengths for most applications  
Instruction for use

Thread repair kits  
สปริงเสริมเกลียว พร้อมอุปกรณ์

### M6-M14x1.5<sup>2</sup>

Order No.						
<b>B5116</b>	M 6x1.0	EBW06	BZ006	6.3mm	10	5
	M 8x1.25	EBW08	BZ008	8.3mm	10	5
	M10x1.5	EBW10	BZ010	10.4mm	5	5
	M12x1.75	EBW12	BZ012	12.4mm	5	5
	M14x1.5 <sup>2</sup>	EBW14		14.4mm	14mm 5	21mm 5

<sup>2</sup> for oil drain plug thread

### M6-M14x1.25<sup>1</sup>

Order No.							
<b>B5108</b>	M 6x1.0	EBW06	BZ006	6.3mm	10	5	
	M 8x1.25	EBW08	BZ008	8.3mm	10	5	
	M10x1.5	EBW10	BZ010	10.4mm	5	5	
	M12x1.75	EBW12	BZ012	12.4mm	5	5	
	M14x1.25 <sup>1</sup>	EBW14			8.4mm 5	12.4mm 5	16.4mm 5

<sup>1</sup> for spark plug thread

### automotive - special

Order No.							
<b>B5109</b>	M 6x1.0	EBW06	BZ006	6.3mm	10	5	
	M10x1.01	EBW10			10mm 5	15mm 5	20mm 5
	M12x1.25 <sup>1</sup>	EBW12			12mm 5	18mm 5	24mm 5
	M12x1.5 <sup>2</sup>		BZ012	12.4mm	12mm 5	18mm 5	
	M14x1.25 <sup>1</sup>	EBW14			8.4mm 5	12.4mm 5	16.4mm 5
	M14x1.5 <sup>2</sup>			14.4mm	21mm 5	21mm 5	

<sup>1</sup> for spark plug thread, <sup>2</sup> for oil drain plug thread

# THREAD REPAIR KITS

สปริงเสริมเกลียว พร้อมอุปกรณ์



ชุดซ่อมเกลียว

Thread Repair Workshop Kits



Drill HSS  
STI Bottoming Tap HSSG  
Inserting Tool  
Tang Break Tool  
Wire Thread Inserts - type: "free running" - length : 1.5D  
Instruction for use

## UNC 1/4 - 1/2"

Order No.					 1.5D
B5120	UNC 1/4x20	EBW06	BZ006	6.7mm	25
	UNC 5/16x18	EBW07	BZ008	8.3mm	25
	UNC 3/8x16	EBW08	BZ008	9.9mm	25
	UNC 7/16x14	EBW10	BZ010	11.6mm	10
	UNC 1/2x13	EBW12	BZ012	13.0mm	10

## UNF 1/4 - 1/2"

Order No.					 1.5D
B5121	UNF 1/4x28	EBW06	BZ006	6.6mm	25
	UNF 5/16x24	EBW07	BZ008	8.3mm	25
	UNF 3/8x24	EBW08	BZ008	9.9mm	25
	UNF 7/16x20	EBW10	BZ010	11.5mm	10
	UNF 1/2x20	EBW12	BZ012	13.0mm	10

## BSW 1/4 - 1/2"

Order No.					 1.5D
B5122	BSW 1/4x20	EBW06	BZ006	6.7mm	25
	BSW 5/16x18	EBW07	BZ008	8.3mm	25
	BSW 3/8x16	EBW08	BZ008	9.9mm	25
	BSW 7/16x14	EBW10	BZ010	11.6mm	10
	BSW 1/2x12	EBW12	BZ012	13.0mm	10

## BSF 1/4 - 1/2"

Order No.					 1.5D
B5123	BSF 1/4x26	EBW06	BZ006	6.6mm	25
	BSF 5/16x22	EBW07	BZ008	8.3mm	25
	BSF 3/8x20	EBW08	BZ008	9.9mm	25
	BSF 7/16x18	EBW10	BZ010	11.5mm	10
	BSF 1/2x16	EBW12	BZ012	13.0mm	10

# THREAD REPAIR KITS

สปริงเสริมเกลียว พร้อมอุปกรณ์



Thread Repair Kits  
สปริงเสริมเกลียว พร้อมอุปกรณ์

Thread repair kits  
สปริงเสริมเกลียว พร้อมอุปกรณ์

ชุดซ่อมเกลียว

## Thread Repair Workshop Kits



Drill Hss  
STI Bottoming Tap HSSG  
Inserting Tool  
Tang Break Tool  
Wire Thread Inserts - type: "free running" - length : 1.5D  
Instruction for use

### G (BSP) British Standard Pipe Thread DIN ISO 228

Please note :

The outside diameter of 1" pipe thread is 33.25mm (not 25.4mm)!

However, the length of the thread insert is Calculated with the value 25.4mm:

e.g.: length 1.5D at G1/4x19:  
1/4x25.4mmx1.5 = 9.525mm

Order No.					1.5D
B5124	G (BSP) 1/8x28	EBW10	BZ010	10.0mm	5
	G (BSP) 1/4x19	EBW12	BZ012	13.5mm	5
	G (BSP) 3/8x19	EBW14		17.0mm	5
	G (BSP) 1/2x14	EBW22			5

### BA British Association Standard Thread BS 93

Order No.					1.5D
B5125	BA 0	EBW06	BZ006	6.2mm	5
	BA 2	EBW05	BZ005	4.9mm	5
	BA 4	EBW03	BZ003	3.8mm	5
	BA 6	EBW02	BZ002	2.9mm	5

leading time : 1-3 weeks

### NPT American Taper Pipe Thread ANSI B1.20.1

Order No.				1.5D
B5126	NPT 1/8x27	EBW10		5
	NPT 1/4x19	EBW14		5
	NPT 3/8x18	EBW14		5
	NPT 1/2x14	EBW22		5

leading time : 1-3 weeks

# THREAD REPAIR KITS

สปริงเสริมเกลียว พร้อมอุปกรณ์



ชุดซ่อมเกลียว สำหรับหัวเทียน

## Thread Repair Workshop Kits for spark plug



STI Bottoming Tap HSSG with pilot nose, for spark plug  
Inserting Tool  
Wire Thread Inserts - type: "free running"  
different lengths for most applications  
Instruction for use

Order No.					
<b>B5113</b>	M 10x1.0	EBW10	10mm 5	15mm 5	20mm 5
	M 12x1.25	EBW12	12mm 5	18mm 5	24mm 5
	M 14x1.25	EBW14	8.4mm 5	12.4mm 5	16.4mm 5

ชุดซ่อมเกลียว สำหรับหัวเทียน

## Thread Repair Workshop Kits for Oil Spark Plug



Drill HSS  
STI Bottoming Tap HSSG  
Inserting Tool  
Wire Thread Inserts - type: "free running"  
different lengths for most applications  
Instruction for use

Order No.					
<b>B5157</b>	M 12x1.5	EBW12	12.4mm	12mm 5	18mm 5
	M 14x1.5	EBW14	14.4mm	14mm 5	21mm 5
	M 16x1.5	EBW14		16mm 5	24mm 5

# THREAD REPAIR KITS

สปริงเสริมเกลียว พร้อมอุปกรณ์



Thread Repair Kits  
สปริงเสริมเกลียว พร้อมอุปกรณ์

ชุดซ่อมเกลียว

## Thread Repair Workshop Kits - PRO



Drill HSS  
STI Machine Tap HSSG  
Countersink HSS with 1/4" hexagon drive (bit shank)  
Machine Inserting Tool with 1/4" hexagon driver (bit shank)  
Tang Break Tool  
Wire Thread Inserts - Type: "free running" - lengths 1.5D - 2.5D  
different lengths for most applications

Thread repair kits

สปริงเสริมเกลียว พร้อมอุปกรณ์

### M3-M12

Order No.							
<b>B5103</b>	M 3x0.5	KEBW03	BZ003	10.4mm	3.2mm	10	5
	M 4x0.7	KEBW04	BZ004		4.2mm	10	5
	M 5x0.8	KEBW05	BZ005		5.2mm	10	5
	M 6x1.0	KEBW06	BZ006		6.3mm	10	5
	M 8x1.25	KEBW08	BZ008	16.5mm	8.3mm	10	5
	M10x1.5	KEBW10	BZ010		10.4mm	5	5
	M12x1.75	KEBW12	BZ012		12.4mm	5	5

### M5-M12

Order No.							
<b>B5106</b>	M 5x0.8	KEBW05	BZ005	10.4mm	5.2mm	10	5
	M 6x1.0	KEBW06	BZ006		6.3mm	10	5
	M 8x1.25	KEBW08	BZ008		8.3mm	10	5
	M10x1.5	KEBW10	BZ010	16.5mm	10.4mm	5	5
	M12x1.75	KEBW12	BZ012		12.4mm	5	5

# THREAD TOOLS

เครื่องมือทำเกลียว

Threading Tools  
เครื่องมือทำเกลียว



ตีบร่องเกลียว สำหรับสปริงเสริมเกลียว

## AL+SP / AL-SP - Spiral Fluted Taps for Helical Coil Wire Screw Thread Inserts

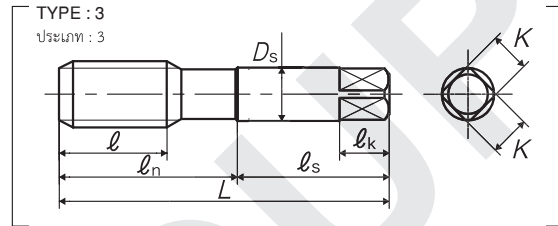
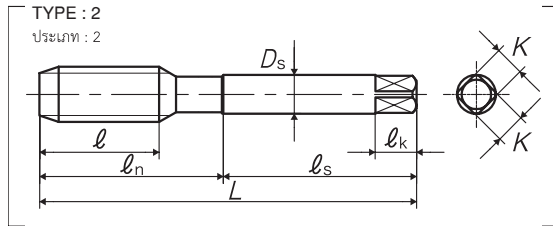
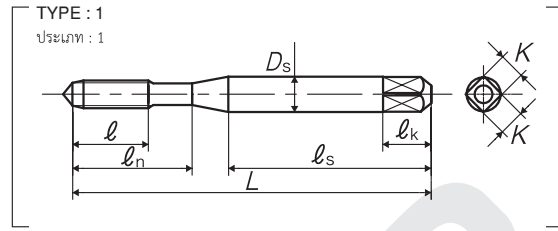

<b>HSS</b>	<b>NI Nitride</b>		<b>Brass</b> 10-25 (m/min)	<b>Brass casting</b> 10-25 (m/min)	<b>Bronze</b> 10-25 (m/min)	<b>Wrought aluminum</b> 10-25 (m/min)	<b>Aluminum alloy castings</b> 10-25 (m/min)	<b>Aluminum alloy die casting</b> 10-25 (m/min)	<b>Zinc alloy castings</b> 10-25 (m/min)
------------	-------------------	--	-------------------------------	---------------------------------------	--------------------------------	--	---	--	---

Recommended Tapping Speeds depending on Materials / ความเร็วรอบจะขึ้นอยู่กับวัสดุที่ใช้ในการต๊าบ

- AL + SP ensures the consistent tapping even in high speed cutting area, in forged workpieces of light alloys such as aluminum die casting and aluminum casting.
- Having optimum cutting edge design, AL + SP does not produce burrs in minor diameter which usually tend to come out during tapping light alloys, and results in cutting of stable and clean internal threads.
- AL+SP สามารถใช้กับงานที่มีรอบความเร็วสูงได้ ใช้กับชิ้นงานที่เป็นโลหะเบา เช่น อลูมิเนียมหล่อฉีด และอลูมิเนียมหล่อ
- เนื่องจากการออกแบบคมตัดที่เหมาะสม AL+SP จะไม่ทำให้เกิดครีบ (bar) ในส่วนของ Minor diameter ที่มักจะเกิดครีบในโลหะเบา ทั้งยังให้ผลลัพธ์ในการต๊าบที่ดี และได้เกลียวที่สะอาดเรียบ

Size ขนาด	Class ระดับ	Code รหัส	Chamfer แซมเฟอร์	Basic major dia. (mm)	L (mm)	l (mm)	ln (mm)	ls (mm)	Ds (mm)	K (mm)	lk (mm)	No. of flutes จำนวนฟัน	Type ประเภท	Stock สต็อก
STI M3x0.5	1b	SW3.0G1LEN	2.5P	3.65	52	7.5	17	29	5	4	7	3	1	○
STI M4x0.7	1b	SW4.0I1LEN	2.5P	4.909	60	13	22	33	5.5	4.5	7	3	1	○
STI M5x0.8	1b	SW5.0K1LEN	2.5P	6.039	62	15	26	33	6	4.5	7	3	1	○
STI M6x1	1b	SW6.0M1LEN	2.5P	7.299	70	19	-	36	6.2	5	8	3	2	○
STI M8x1.25	1b	SW8.0N1LEN	2.5P	9.624	75	23	-	38	7	5.5	8	3	2	○
STI M10x1.5	1b	SW010O1LEN	2.5P	11.948	82	26	-	42	8.5	6.5	9	3	2	○
STI M10x1.25	1b	SW010N1LEN	2.5P	11.624	82	26	-	42	8.5	6.5	9	3	2	△
STI M12x1.75	1b	SW012P1LEN	2.5P	14.273	95	26	-	48	12.5	10	13	3	2	○
STI M12x1.5	1b	SW012O1LEN	2.5P	13.948	88	26	-	45	10.5	8	11	3	2	△
STI M12x1.25	1b	SW012N1LEN	2.5P	13.624	88	26	-	45	10.5	8	11	3	2	△
STI M14x2	1b	SW014Q1LEN	2.5P	16.598	100	33	-	51	14	11	14	3	2	△
STI M14x1.5	1b	SW014O1LEN	2.5P	15.948	95	26	-	48	12.5	10	13	3	2	△
STI M16x2	1b	SW016Q1LEN	2.5P	18.598	105	33	-	50	15	12	15	4	3	○
STI M16x1.5	1b	SW016O1LEN	2.5P	17.948	100	33	-	51	14	11	14	4	3	△
STI M18x2.5	1b	SW018R1LEN	2.5P	21.248	115	33	-	55	17	13	16	4	3	△
STI M18x1.5	1b	SW018O1LEN	2.5P	19.948	105	33	-	50	15	12	15	4	3	△
STI M20x2.5	1b	SW020R1LEN	2.5P	23.248	120	39	-	55	19	15	18	4	3	○
STI M20x1.5	1b	SW020O1LEN	2.5P	21.948	115	33	-	55	17	13	16	4	3	△
STI M22x2.5	1b	SW022R1LEN	2.5P	25.248	125	39	-	58	19	15	18	4	3	△
STI M24x3	1b	SW024S1LEN	2.5P	27.897	135	46	-	62	23	17	20	4	3	○

## ตีบร่องตรง สำหรับสปริงเสริมเกลียว

### AL-PO - Spiral Pointed Taps for Coil Wire Screw Thread Inserts

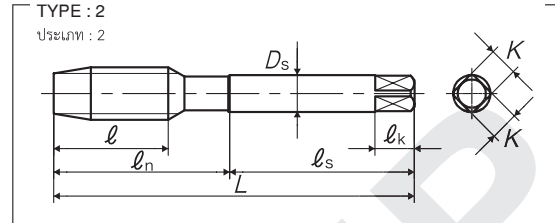
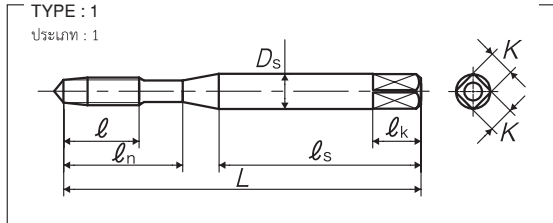

Recommended Tapping Speeds depending on Materials / ความเร็วรอบจะขึ้นอยู่กับวัสดุที่ใช้ในการต๊าบ

■ Spiral pointed tap suitable for high carbon steels such as S55C and the like.

■ ต๊าบร่องตรง สำหรับงานเหล็กคาร์บอนสูง เช่น S55C และใกล้เคียง

Size ขนาด	Class ระดับ	Code รหัส	Chamfer แฉมเพอร์	Basic major dia	L (mm)	l (mm)	ln (mm)	ls (mm)	Ds (mm)	K (mm)	lk (mm)	No. of flutes จำนวนฟัน	Type ประเภท	Stock สต็อก
For Helical Coil Wire Screw Thread Inserts, for Metric Threads / สำหรับทำสปริงเสริมเกลียว, สำหรับเกลียวเมตริก														
STI M3x0.5	1b	-	5P	3.65	52	7.5	17	29	5	4	7	3	1	△
STI M4x0.7	1b	-	5P	4.909	60	13	22	33	5.5	4.5	7	3	1	△
STI M5x0.8	1b	-	5P	6.039	62	15	26	33	6	4.5	7	3	1	△
STI M6x1	1b	-	5P	7.299	70	19	-	36	6.2	5	8	3	2	△
STI M8x1.25	1b	-	5P	9.624	75	23	-	38	7	5.5	8	3	2	△
STI M10x1.5	1b	-	5P	11.948	82	26	-	42	8.5	6.5	9	3	2	△
STI M12x1.75	1b	-	5P	14.273	95	26	-	48	12.5	10	13	3	2	△

## ตีบมือ สำหรับสปริงเสริมเกลียว

### AL-HT - Hand Taps for Helical Coil Wire Screw Thread Inserts

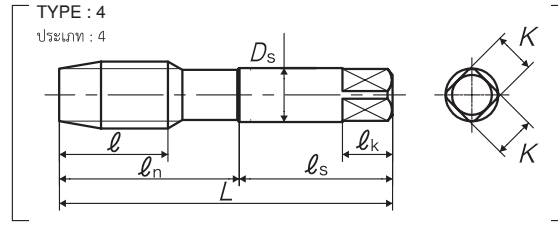
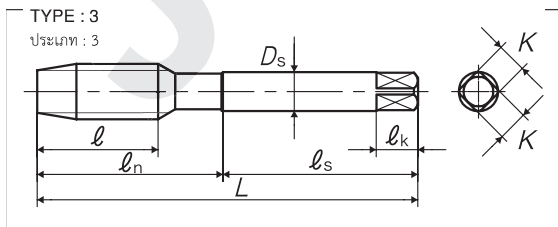
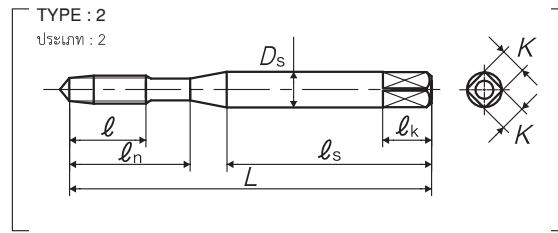
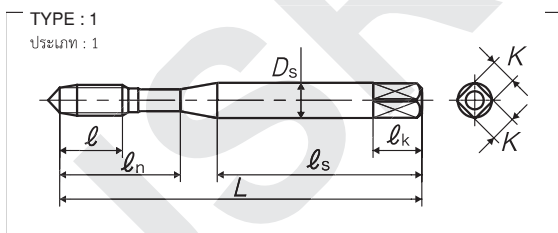

Recommended Tapping Speeds depending on Materials / ความเร็วรอบจะขึ้นอยู่กับวัสดุที่ใช้ในการต๊าบ

■ Hand tap cutting internal threads for helical coil to enter.

■ ต๊าบมือที่เหมาะสมกับงานสปริงเสริมเกลียว

Carbide

คาร์ไบด์

HSS

ไฮสปีด

for Steel  
สำหรับเหล็ก

for Stainless Steel  
สำหรับสแตนเลส

for Aluminum  
สำหรับอะลูมิเนียม

for Titanium  
สำหรับไททาเนียม

for Nickel Base Alloy  
สำหรับนิกเกิล

for Cast Iron  
สำหรับเหล็กหล่อ

for Die Cast Iron  
สำหรับเหล็กหล่อเหนียว

for Magnesium  
Alloy Castings  
สำหรับแมกนีเซียม  
อัลลอยหล่อ

for Plastics  
สำหรับพลาสติก

for Thin soft  
structural steel  
sheet  
สำหรับแผ่นเหล็กนิ่ม

for Non-ferrous  
material  
สำหรับวัสดุที่ไม่ใช่เหล็ก

# THREAD TOOLS

เครื่องมือทำเกลียว



Threading Tools  
เครื่องมือทำเกลียว

Size ขนาด	Class ระดับ	Code รหัส	Chamfer แซมเฟอร์	Basic major dia (mm)	L (mm)	l (mm)	l <sub>n</sub> (mm)	l <sub>s</sub> (mm)	Ds (mm)	K (mm)	l <sub>k</sub> (mm)	No. of flutes จำนวนฟัน	Type ประเภท	Stock สต็อก
--------------	----------------	--------------	---------------------	----------------------------	-----------	-----------	------------------------	------------------------	------------	-----------	------------------------	---------------------------	----------------	----------------

For Helical Coil Wire Screw Thread Inserts, for Metric Threads / สำหรับทำสปริงเสริมเกลียว, สำหรับเกลียวเมตริก

STI M2.6x0.45	1b	TW2.6F1LEB5	5P	3.185	52	6.8	16	29	5	4	7	3	1	△
		TW2.6F1LEBA	1.5P											
STI M3x0.5	1b	TW3.0G1LEB5	5P	3.650	52	7.5	17	29	5	4	7	3	1	◎
		TW3.0G1LEBA	1.5P											
STI M4x0.7	1b	TW4.0I1LEB5	5P	4.909	60	13	22	33	5.5	4.5	7	4	2	◎
		TW4.0I1LEBA	1.5P											
STI M5x0.8	1b	TW5.0K1LEB5	5P	6.039	62	15	26	33	6	4.5	7	4	2	◎
		TW5.0K1LEBA	1.5P											
STI M6x1	1b	TW6.0M1LEB5	5P	7.299	70	19	-	36	6.2	5	8	4	3	◎
		TW6.0M1LEBA	1.5P											
STI M8x1.25	1b	TW8.0N1LEB5	5P	9.624	75	23	-	38	7	5.5	8	4	3	◎
		TW8.0N1LEBA	1.5P											
STI M10x1.5	1b	TW10.0O1LEB5	5P	11.949	82	26	-	42	8.5	6.5	9	4	3	◎
		TW10.0O1LEBA	1.5P											
STI M10x1.25	1b	TW10.0N1LEB5	5P	11.624	82	26	-	42	8.5	6.5	9	4	3	△
		TW10.0N1LEBA	1.5P											
STI M10x1	1b	TW10.0M1LEB5	5P	11.299	82	26	-	42	8.5	6.5	9	4	3	△
		TW10.0M1LEBA	1.5P											
STI M12x1.75	1b	TW12.0P1LEB5	5P	14.273	95	26	-	48	12.5	10	13	4	3	◎
		TW12.0P1LEBA	1.5P											
STI M12x1.5	1b	TW12.0O1LEB5	5P	13.948	88	26	-	45	10.5	8	11	4	3	△
		TW12.0O1LEBA	1.5P											
STI M12x1.25	1b	TW12.0N1LEB5	5P	13.624	88	26	-	45	10.5	8	11	4	3	△
		TW12.0N1LEBA	1.5P											
STI M14x2	1b	TW14.0Q1LEB5	5P	16.598	100	33	-	51	14	11	14	4	3	△
		TW14.0Q1LEBA	1.5P											
STI M14x1.5	1b	TW14.0I1LEB5	5P	15.948	95	26	-	48	12.5	10	13	4	3	△
		TW14.0I1LEBA	1.5P											
STI M16x2	1b	TW16.0Q1LEB5	5P	18.598	105	33	-	50	15	12	15	4	4	◎
		TW16.0Q1LEBA	1.5P											
STI M16x1.5	1b	TW16.0O1LEB5	5P	17.948	100	33	-	51	14	11	14	4	3	△
		TW16.0O1LEBA	1.5P											
STI M18x2.5	1b	TW18.0R1LEB5	5P	21.248	115	33	-	55	17	13	16	4	4	△
		TW18.0R1LEBA	1.5P											
STI M18x1.5	1b	TW18.0O1LEB5	5P	19.948	105	33	-	50	15	12	15	4	4	△
		TW18.0O1LEBA	1.5P											
STI M20x2.5	1b	TW20.0R1LEB5	5P	23.248	120	39	-	55	19	15	18	4	4	◎
		TW20.0R1LEBA	1.5P											
STI M20x1.5	1b	TW20.0O1LEB5	5P	21.948	115	33	-	55	17	13	16	4	4	△
		TW20.0O1LEBA	1.5P											
STI M22x2.5	1b	TW22.0R1LEB5	5P	25.248	125	39	-	58	19	15	18	4	4	△
		TW22.0R1LEBA	1.5P											
STI M22x1.5	1b	TW22.0O1LEB5	5P	23.948	120	39	-	55	19	15	18	4	4	△
		TW22.0O1LEBA	1.5P											
STI M24x3	1b	TW24.0S1LEB5	5P	27.897	135	46	-	62	23	17	20	4	4	◎
		TW24.0S1LEBA	1.5P											
STI M24x1.5	1b	TW24.0O1LEB5	5P	25.948	130	39	-	60	20	15	18	4	4	△
		TW24.0O1LEBA	1.5P											

For Helical Coil Wire Screw Thread Inserts, for Unified Threads / สำหรับทำสปริงเสริมเกลียว, สำหรับเกลียวนิ้ว

STI No.4-40UNC	1b	TWUN4H1LEB5	5P	3.670	52	11	17	29	5	4	7	3	2	△
		TWUN4H1LEBA	1.5P											
STI No.4-48UNF	1b	TWUN4F1LEB5	5P	3.532	52	11	17	29	5	4	7	3	2	△
		TWUN4F1LEBA	1.5P											
STI No.5-40UNC	1b	TWUN5H1LEB5	5P	4.000	52	11	17	29	5	4	7	3	2	△
		TWUN5H1LEBA	1.5P											
STI No.6-32UNC	1b	TWUN6J1LEB5	5P	4.536	60	13	22	33	5.5	4.5	7	3	2	△
		TWUN6J1LEBA	1.5P											
STI No.6-40UNF	1b	TWUN6H1LEB5	5P	4.330	60	13	22	33	5.5	4.5	7	3	2	△
		TWUN6H1LEBA	1.5P											
STI No.8-32UNC	1b	TWUN8J1LEB5	5P	5.197	62	15	26	33	6	4.5	7	4	2	△
		TWUN8J1LEBA	1.5P											

Size ขนาด	Class ระดับ	Code รหัส	Chamfer แฉมเฟอร์	Basic major dia (mm)	L (mm)	l (mm)	l <sub>n</sub> (mm)	l <sub>s</sub> (mm)	D <sub>s</sub> (mm)	K (mm)	l <sub>k</sub> (mm)	No. of flutes จำนวนฟัน	Type ประเภท	Stock สต็อก
STI No.8-36UNF	1b	TWUN811LEB5	5P	5.083	62	9.5	26	33	6	4.5	7	4	1	△
		TWUN811LEBA	1.5P											
STI No.10-24UNC	1b	TWUNAM1LEB5	5P	6.200	62	15	26	33	6	4.5	7	4	2	△
		TWUNAM1LEBA	1.5P											
STI No.10-32UNF	1b	TWUNAJ1LEB5	5P	5.857	62	15	26	33	6	4.5	7	4	2	△
		TWUNAJ1LEBA	1.5P											
STI No.12-24UNC	1b	TWUNCM1LEB5	5P	6.861	70	19	-	36	6.2	5	8	4	3	△
		TWUNCM1LEBA	1.5P											
STI 1/4-20UNC	1b	TWU04N1LEB5	5P	8.000	70	19	-	36	6.2	5	8	4	3	△
		TWU04N1LEBA	1.5P											
STI 1/4-28UNF	1b	TWU04K1LEB5	5P	7.528	70	19	-	36	6.2	5	8	4	3	△
		TWU04K1LEBA	1.5P											
STI 5/16-18UNC	1b	TWU05O1LEB5	5P	9.771	75	23	-	38	7	5.5	8	4	3	△
		TWU05O1LEBA	1.5P											
STI 5/16-24UNF	1b	TWU05M1LEB5	5P	9.313	75	23	-	38	7	5.5	8	4	3	△
		TWU05M1LEBA	1.5P											
STI 3/8-16UNC	1b	TWU06P1LEB5	5P	11.587	82	26	-	42	8.5	6.5	9	4	3	△
		TWU06P1LEBA	1.5P											
STI 3/8-24UNF	1b	TWU06M1LEB5	5P	10.900	82	26	-	42	8.5	6.5	9	4	3	△
		TWU06M1LEBA	1.5P											
STI 7/16-14UNC	1b	TWU07Q1LEB5	5P	13.469	88	26	-	45	10.5	8	11	4	3	△
		TWU07Q1LEBA	1.5P											
STI 7/16-20UNF	1b	TWU07N1LEB5	5P	12.762	88	26	-	45	10.5	8	11	4	3	△
		TWU07N1LEBA	1.5P											
STI 1/2-13UNC	1b	TWU08R1LEB5	5P	15.238	95	26	-	48	12.5	10	13	4	3	△
		TWU08R1LEBA	1.5P											
STI 1/2-20UNF	1b	TWU08N1LEB5	5P	14.350	95	26	-	48	12.5	10	13	4	3	△
		TWU08N1LEBA	1.5P											
STI 5/8-11UNC	1b	TWU10U1LEB5	5P	18.875	105	33	-	50	15	12	15	4	4	△
		TWU10U1LEBA	1.5P											
STI 5/8-18UNF	1b	TWU10O1LEB5	5P	17.708	100	33	-	51	14	11	14	4	3	△
		TWU10O1LEBA	1.5P											
STI 3/4-16UNF	1b	TWU12P1LEB5	5P	21.112	115	33	-	55	17	13	16	4	4	△
		TWU12P1LEBA	1.5P											

Carbide

คาร์ไบด์

HSS

ไฮสปีด

for Steel  
สำหรับเหล็ก

for Stainless Steel  
สำหรับสแตนเลส

for Aluminum  
สำหรับอะลูมิเนียม

for Titanium  
สำหรับไททาเนียม

for Nickel Base Alloy  
สำหรับนิกเกิล

for Cast Iron  
สำหรับเหล็กหล่อ

for Die Cast Iron  
สำหรับเหล็กหล่อเหนียว

for Magnesium  
Alloy Castings  
สำหรับแมกนีเซียม  
อัลลอยหล่อ

for Plastics  
สำหรับพลาสติก

for Thin soft  
structural steel  
sheet

สำหรับแผ่นเหล็กนิ่ม

for Non-ferrous  
material  
สำหรับวัสดุที่ไม่ใช่เหล็ก

## ตีบรีดเกลียว สำหรับวัสดุที่ไม่ใช่เหล็ก

### N+RS / N-RS - Thread Forming Taps for Non-Ferrous Materials

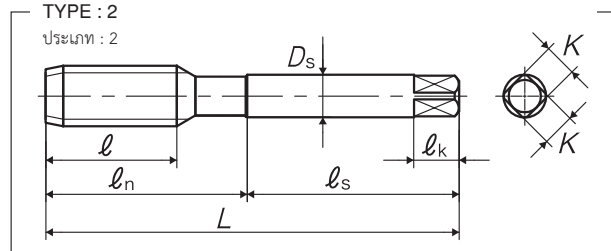
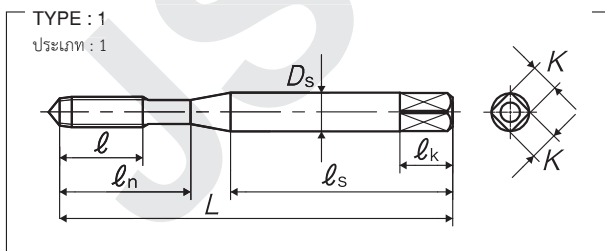

HSS	NI Nitride	Wrought aluminum น้ำหนักเบา 5-15 (m/min)	Aluminum alloy castings น้ำหนักเบา 5-15 (m/min)	Zinc alloy castings น้ำหนักเบา 5-15 (m/min)
-----	---------------	---	--	--

Recommended Tapping Speeds depending on Materials / ความเร็วรอบจะขึ้นอยู่กับวัสดุที่ใช้ในการตอก

■ N+RS/N-RS are the forming taps suitable for non-ferrous materials such as aluminum castings, aluminum diecasting and brass.

■ N+RS/N-RS เหมาะสำหรับการตอกที่ใช้วัสดุที่ไม่ใช่เหล็ก เช่น อลูมิเนียม, อลูมิเนียมขึ้นรูปหล่อ และทองเหลือง

Size ขนาด	Class ระดับ	Code รหัส	Chamfer แฉมเฟอร์	Basic major dia (mm)	L (mm)	l (mm)	l <sub>n</sub> (mm)	l <sub>s</sub> (mm)	D <sub>s</sub> (mm)	K (mm)	l <sub>k</sub> (mm)	Lobe ร่อง	Type ประเภท	Stock สต็อก
--------------	----------------	--------------	---------------------	-------------------------	-----------	-----------	------------------------	------------------------	------------------------	-----------	------------------------	--------------	----------------	----------------

For Helical Coil Wire Screw Thread Inserts, for Metric Threads / สำหรับทาสปริงเสริมเกลียว, สำหรับเกลียวเมตริก

STI M3x 0.5	G3	RW3.0G3LENP	4P	3.65	52	7.5	17	29	5	4	7	4	1	△
		RW3.0G3LENB	2P											

# THREAD TOOLS

เครื่องมือทำเกลียว

Threading Tools  
เครื่องมือทำเกลียว



Size ขนาด	Class ระดับ	Code รหัส	Chamfer แฉมเฟอร์	Basic major dia (mm)	L (mm)	ℓ (mm)	ℓ n (mm)	ℓ s (mm)	Ds (mm)	K (mm)	ℓ k (mm)	Lobe ร่อง	Type ประเภท	Stock สต็อก
STI M4x 0.7	G4	RW4.0I4LENP	4P	4.909	60	13	22	33	5.5	4.5	7	4	1	△
		RW4.0I4LENB	2P											
STI M5x 0.8	G4	RW5.0K4LENP	4P	6.039	62	15	26	33	6	4.5	7	4	1	△
		RW5.0K4LENB	2P											
STI M6x 1	G4	RW6.0M4LENP	4P	7.299	70	19	-	36	6.2	5	8	4	2	△
		RW6.0M4LENB	2P											
STI M8x 1.25	G4	RW8.0N4LENB	2P	9.624	75	23	-	38	7	5.5	8	6	2	△
STI M10x 1.5	G5	RW010O5LENB	2P	11.948	82	26	-	42	8.5	6.5	9	6	2	△
STI M12x 1.75	G6	RW012P6LENB	2P	14.273	95	26	-	48	12.5	10	13	6	2	△

ตีบคาร์ไบด์ สำหรับอลูมิเนียม

## N-CT LA - Carbide Taps for Light Alloys

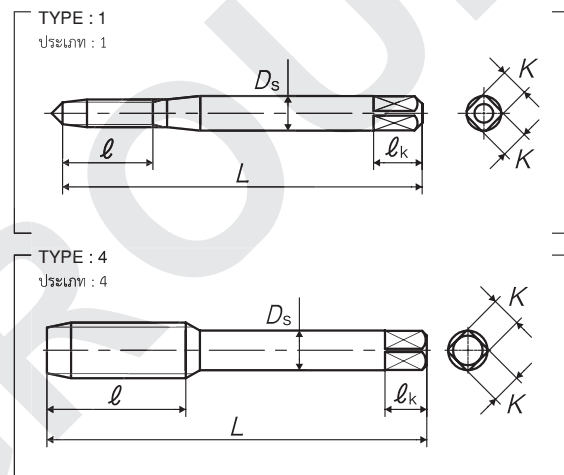

Recommended Tapping Speeds depending on Materials / ความเร็วรอบจะขึ้นอยู่กับวัสดุที่ใช้ในการตีบ

■ N-CT LA is the carbide tap suitable for tapping aluminum castings (AC), aluminum die castings (ADC), and zinc diecastings (ZDC). For volume production.

■ N-CT LA เป็นตีบคาร์ไบด์ สำหรับงานอลูมิเนียมหล่อ, วัสดุขึ้นรูปหล่อ

Size ขนาด	Class ระดับ	Code รหัส	Chamfer แฉมเฟอร์	Basic major dia (mm)	L (mm)	ℓ (mm)	ℓ n (mm)	Ds (mm)	K (mm)	ℓ k (mm)	No. of flutes จำนวนฟัน	Type ประเภท	Stock สต็อก
STI M3x0.5	1b	TW3.0G1LWB5	5P	3.65	52	13	-	5	4	7	3	1	△
		TW3.0G1LWBA	1.5P										
STI M4x0.7	1b	TW4.0I1LWB5	5P	4.909	60	16	-	5.5	4.5	7	3	1	△
		TW4.0I1LWBA	1.5P										
STI M5x0.8	1b	TW5.0K1LWB5	5P	6.039	62	19	-	6	4.5	7	3	2	△
		TW5.0K1LWBA	1.5P										
STI M6x1	1b	TW6.0M1LWB5	5P	7.299	65	19	-	6.2	5	8	4	3	△
		TW6.0M1LWBA	1.5P										
STI M8x1.25	1b	TW8.0N1LWB5	5P	9.624	75	24	-	7	5.5	8	4	3	△
		TW8.0N1LWBA	1.5P										
STI M10x1.5	1b	TW010O1LWB5	5P	11.948	82	30	-	8.5	6.5	9	4	3	△
		TW010O1LWBA	1.5P										

For Helical Coil Wire Screw Thread Inserts, for Metric Threads / สำหรับทำสปริงเสริมเกลียว, สำหรับเกลียวเมตริก



## ตีวามเกลียวสำหรับสปริงเสริมเกลียว

### Bottoming Taps for Wire Thread Insert

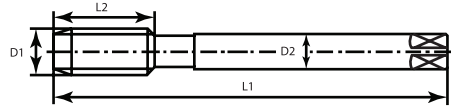

Bottoming Taps can be used by hand or machine

#### Work Standard

Order No.	M	D1	D2	L1	L2	□	🔩
B3001	M2x0.4	2.52	2.80	44.5	9.5	2.24	2.1
B3002	M2.2x0.45	2.79	3.15	48.0	11.0	2.50	2.3
B3003	M2.5x0.45	3.09	3.15	48.0	11.0	2.50	2.6
B3005	M3x0.5	3.65	3.50	53.0	16.5	2.70	3.2
B3006	M3.5x0.6	4.28	4.50	53.0	13.0	3.55	3.7
B3007	M4x0.7	4.91	4.90	63.0	22.0	4.00	4.2
B3008	M5x0.8	6.04	6.45	68.0	25.0	5.00	5.3
B3071	M6x0.75	6.98	8.00	72.0	22.0	6.30	6.2
B3009	M6x1.0	7.30	8.00	72.0	28.0	6.00	6.3
B3010	M7x1.0	8.30	9.60	77.0	33.0	7.20	7.3
B3072	M8x0.75	8.90	10.00	80.0	24.0	8.00	8.2
B3012	M8x1.0	9.30	9.60	77.0	33.0	7.20	8.3
B3011	M8x1.25	9.62	9.60	77.0	32.0	7.20	8.3
B3073	M9x1.0	10.30	8.00	85.0	25.0	6.30	9.3
B3013	M9x1.25	10.62	8.0	85.0	25.0	6.30	9.3
B3017	M10x1.0	11.30	8.10	80.0	36.0	6.00	10.3
B3016	M10x1.25	11.62	9.20	85.0	42.0	7.00	10.3
B3015	M10x1.5	11.95	9.20	85.0	42.0	7.00	10.4
B3074	M11x1.0	12.25	9.00	89.0	29.0	7.10	11.3
B3075	M11x1.25	12.62	9.00	89.0	29.0	7.10	11.3
B3018	M11x1.5	12.95	9.00	89.0	29.0	7.10	11.4
B3023	M12x1.0	13.30	9.00	95.0	30.0	11.20	12.3
B3022	M12x1.25	13.62	10.90	91.0	42.0	8.00	12.3
B3021	M12x1.5	13.95	10.90	91.0	42.0	8.00	12.4
B3020	M12x1.75	14.2	10.90	91.5	42.0	8.00	12.4
B3076	M13x1.25	14.62	12.50	102.0	32.0	11.20	13.4
B3077	M13x1.5	14.95	12.50	102.0	32.0	11.20	13.4
B3078	M13x1.75	15.25	12.50	102.0	32.0	11.20	13.4
B3030	M14x1.0	15.30	12.5	102	32	10.0	14.4
B3029	M14x1.25	15.57	12.1	96	46	9.0	14.4
B3028	M14x1.5	15.95	12.1	96	46	9.0	14.5
B3027	M14x2.0	16.60	12.5	102	32	10.0	14.5
B3079	M15x1.5	16.95	14.0	102	37	11.2	15.5
B3080	M15xx2.0	17.60	14.0	102	37	11.2	15.5
B3034	M16x1.5	17.95	14.0	104	29	11.2	16.5
B3033	M16x2.0	18.60	14.0	112	37	11.2	16.5
B3037	M18x1.5	19.95	16.5	113	51	12.5	18.5
B3036	M18x2.0	20.60	14.0	104	29	11.2	18.5
B3035	M18x2.5	21.25	16.0	118	38	12.5	18.5
B3040	M20x1.5	21.95	16.0	113	33	12.5	20.5
B3039	M20x2.0	22.60	16.0	113	33	12.5	20.5
B3038	M20x2.5	23.25	16.0	118	38	12.5	20.5
B3043	M22x1.5	23.95	18.0	120	35	14.0	22.5
B3042	M22x2.0	24.60	18.0	120	35	14.0	22.5
B3041	M22x2.5	25.25	18.0	130	45	12.5	22.5
B3046	M24x1.5	26.02	18.0	120	35	14.0	24.5
B3045	M24x2.0	26.60	20.0	127	37	16.0	24.5
B3044	M24x3.0	27.90	20.0	138	48	16.0	24.5
B3049	M26x1.5	27.95	20.0	127	37	16.0	26.5
B3052	M27x1.5	28.95	20.0	127	37	16.0	27.5
B3051	M27x2.0	29.60	20.0	127	37	16.0	27.5
B3050	M27x3.0	30.90	22.4	151	51	18.0	27.5
B3053	M28x1.5	29.95	20.0	127	37	16.0	28.5

Carbide  
คาร์ไบด์

HSS  
ไฮสปีด

for Steel  
สำหรับเหล็ก

for Stainless Steel  
สำหรับสแตนเลส

for Aluminum  
สำหรับอะลูมิเนียม

for Titanium  
สำหรับไททานเนียม

for Nickel Base Alloy  
สำหรับนิกเกิล

for Cast Iron  
สำหรับเหล็กหล่อ

for Die Cast Iron  
สำหรับเหล็กหล่อเหนียว

for Magnesium  
Alloy Castings  
สำหรับแมกนีเซียม  
อัลลอยหล่อ

for Plastics  
สำหรับพลาสติก

for Thin soft  
structural steel  
sheet  
สำหรับแผ่นเหล็กนิ่ม

for Non-ferrous  
material  
สำหรับวัสดุที่ไม่ใช่เหล็ก

# THREAD TOOLS

เครื่องมือทำเกลียว



Threading Tools

เครื่องมือทำเกลียว

Order No.	M	D1	D2	L1	L2	□	
<b>B3056</b>	M30x1.5	31.95	22.4	137	37	18.0	30.5
<b>B3081</b>	M30x3.0	33.90	22.4	137	37	18.0	30.5
<b>B3055</b>	M30x2.0	32.60	22.4	137	37	18.0	30.5
<b>B3054</b>	M30x3.5	34.55	25.0	162	57	20.0	30.5
<b>B3066</b>	M39x2.0	41.60	31.5	187	67	25.0	39.5
<b>B3058</b>	M33x2.0	35.60	25.0	144	37	20.0	33.5
<b>B3057</b>	M33x3.5	37.55	25.0	162	57	20.0	33.5
<b>B3063</b>	M36x1.5	37.95	28.0	150	39	22.4	36.5
<b>B3062</b>	M36x2.0	38.60	28.0	150	39	22.4	36.5
<b>B3061</b>	M36x3.0	39.90	28.0	170	60	22.4	36.5
<b>B3060</b>	M36x4.0	41.20	28.0	170	60	22.4	36.5
<b>B3065</b>	M39x3.0	42.90	31.5	187	67	25.0	39.5
<b>B3064</b>	M39x4.0	44.20	31.5	187	67	25.0	39.5
<b>B3070</b>	M42x2.0	44.60	35.5	200	70	28.0	42.5
<b>B3069</b>	M42x3.0	45.90	35.5	200	70	28.0	42.8
<b>B3068</b>	M42x4.0	47.20	35.5	200	70	28.0	43.0
<b>B3067</b>	M42x4.5	47.85	35.5	200	70	28.0	43.0

Carbide

คาร์ไบด์

HSS

ไฮสปีด

for Steel

สำหรับเหล็ก

for Stainless Steel

สำหรับสแตนเลส

for Aluminum

สำหรับอะลูมิเนียม

for Titanium

สำหรับไทเทเนียม

for Nickel Base Alloy

สำหรับนิกเกิล

for Cast Iron

สำหรับเหล็กหล่อ

for Die Cast Iron

สำหรับเหล็กหล่อเหนียว

for Magnesium Alloy Castings

สำหรับแมกนีเซียมอัลลอยหล่อ

for Plastics

สำหรับพลาสติก

for Thin soft structural steel sheet

สำหรับแผ่นเหล็กนิ่ม

for Non-ferrous material

สำหรับวัสดุที่ไม่ใช่เหล็ก



## ด้ามใส่สปริงเสริมเกลียว Inserting Tools



### Installation

Toos  
เครื่องมือในการติดตั้ง

with locking ring for depth stop

Order No.	M	M	UNC UNF	BSW BSF	BA G (BSP) NPT	UNEF Harley BSC BSB	length	□
<b>EBW03</b>	M3x0.5	M3.5x0.6	UNC4x40 UNC5x40 UNC6x32 UNF4x48 UNF6x40	BSW1/8x40	5BA		100	5
<b>EBW04</b>	M4x0.7		UNC8x32 UNC10x24 UNF8x36	BSF3/16x32	4BA 3BA		100	5
<b>EBW05</b>	M5x0.8		UNC12x24 UNF10x32	BSW3/16x24 BSF7/32x28	2BA 1BA		100	5
<b>EBW06</b>	M6x1.0 M6x0.75		UNC1/4x20 UNF1/4x28	BSW1/4x20 BSF1/4x26 BSF9/32x26	0BA	UNEF1/4x32 Harley1/4x24 BSB1/4x26	100	5
<b>EBW07</b>	M7x1.0		UNC5/16x18 UNF5/16x24	BSW5/16x18 BSF5/16x22		BSC5/16x26 BSB5/16x26	100	7
<b>EBW08</b>	M8x1.25 M8x1.0 M8x0.75	M9x1.25 M9x1.0	UNC3/8x16 UNF3/8x24	BSW3/8x16 BSF3/8x20		BSC3/8x26 BSB3/8x26	100	7
<b>EBW10</b>	M10x1.5 M10x1.25 M10x1.0	M11x1.5 M11x1.25 M11x1.0	UNC7/16x14 UNF7/16x20	BSW7/16x14 BSF7/16x18	G1/8x28 NPT1/8x27	Harley7/16x16 BSC7/16x26 BSB7/16x26	100	7
<b>EBW12</b>	M12x1.75 M12x1.5 M12x1.25	M12x1.0 M13x1.5 M13x1.25	UNC1/2x13 UNF1/2x20	BSW1/2x12 BSF1/2x16	G1/4x19	BSC1/2x26 BSB1/2x26	100	7
<b>EBW14</b>	M14x2.0 M14x1.5 M14x1.25 M14x1.0	M15x2.0 M15x1.5 M16x2.0 M16x1.5	UNC9/16x12 UNC5/8x11 UNF9/16x18 UNF5/8x18	BSW9/16x12 BSW5/8x11 BSF9/16x16 BSF5/8x14	G3/8x19 NPT1/4x19	11/16x16	100	7

### Compatibility

BaerCoil ® wire thread and tools are compatible with wire thread inserts and tools other manufacturers. BaerCoil ® insert are mainly manufactured according to DIN 8140 so they have the same dimensions. Other standards like DIN65536, EN2944, LN9039, LN9490, LN9499, NASM21209, AS4736 to 4748, to 3799, MA3279 to 3281 and NASM214850 ect. are available, too.

# INSTALLATION TOOLS

เครื่องมือในการติดตั้ง



ตามใส่สปริงเสริมเกลียว  
Inserting Tools



with locking ring for depth stop

Order No.	M	UNC UNF	BSW BSF	G (BSP) NPT	8-UN
<b>EBW01</b>	M2x0.4 M2.2x0.45	UNC2x56 UNF2x64			
<b>EBW02</b>	M2.5x0.45	UNC3x48 UNF3x56		BA6	
<b>EBW18</b>	M18x2.5 M18x2.0 M18x1.5	UNC3/4x10	BSW3/4x10 BSF3/4x12 BSF13/16x12		
<b>EBW20</b>	M20x2.5 M20x2.0 M20x1.5	UNF3/4x16			
<b>EBW22</b>	M22x2.5 M22x2.0 M22x1.5	UNC7/8x9 UNF7/8x14	BSW7/8x9 BSF7/8x11	G1/2x14 NPT1/2x14	
<b>EBW24</b>	M24x3.0 M24x2.0 M24x1.5	UNC1"x8 UNF1"x12 UNF1"x14	BSW1"x8 BSF1"x10		1"x20
<b>EBW26</b>	M26x1.5 M27x2.0 M27x1.5	UNC1.1/8"x7	BSW1.1/8"x7	G3/8x14 NPT3/4x14	UN1.1/8"x8
<b>EBW28</b>	M28x1.5				
<b>EBW30</b>	M30x3.5 M30x3.0	UNC1.1/4"x7 UNF1.1/8"x12	BSW1.1/4"x7 BSF1.1/8"x9		UN1.1/4"x8
<b>EBW31</b>	M30x2.0 M30x1.5	UNC1.3/8"x6 UNF1.1/4"x12	BSW1.3/8"x6 BSF1.1/4"x9	G7/8x14	UN1.3/8"x8
<b>EBW33</b>	M33x3.5 M33x2.0				
<b>EBW36</b>	M36x4.0 M36x3.0	UNC1.1/2"x6 UNF1.3/8"x12	BSW1.1/2"x6 BSF1.3/8"x8	G1"x11 NPT1"x11.5	UN1.1/2"x8
<b>EBW39</b>	M36x1.5 M39x4.0 M39x3.0 M39x2.0	UNF1.1/2"x12	BSF1.1/2"x8		UN1.5/8"x8
<b>EBW42</b>	M42x4.5 M42x4.0 M42x3.0 M42x2.0			G1.1/4x11	UN1.3/4"x8 UN1.7/8"x8 UN2"x8



## ด้ามหักสปริงเสริมเกลียว Tang Break Tools



Installation  
Tools  
เครื่องมือในการติดตั้ง

Order No.	M	M	UNC UNF	BSW BSF	BA G (BSP) NPT	UNEF Harley BSC BSB	length
<b>BZ001</b>	M2x0.4	M2.2x0.45	UNC2x56 UNF2x64				
<b>BZ002</b>	M2.5x0.45		UNC3x48 UNF3x56		6BA		
<b>BZ003</b>	M3x0.5	M3.5x0.6	UNC4x40 UNC5x40 UNC6x32 UNF4x48 UNF6x40	BSW1/8x40	5BA		100
<b>BZ004</b>	M4x0.7		UNC8x32 UNC10x24 UNF8x36	BSF3/16x32	4BA 3BA		100
<b>BZ005</b>	M5x0.8		UNC12x24 UNF10x32	BSW3/16x24 BSF7/32x28	2BA 1BA		100
<b>BZ006</b>	M6x1.0 M6x0.75	M7x1.0	UNC1/4x20 UNF1/4x28 UNC5/16x18 UNF5/16x24	BSW1/4x20 BSF1/4x26 BSF9/32x26 BSW5/16x18 BSF5/16x22	0BA	UNEF1/4x32 Harley1/4x24 BSB1/4x26 BSC5/16x26 BSB5/16x26	100
<b>BZ008</b>	M8x1.25 M8x1.0 M8x0.75	M9x1.25 M9x1.0	UNC3/8x16 UNF3/8x24	BSW3/8x16 BSF3/8x20		BSC3/8x26 BSB3/8x26	100
<b>BZ010</b>	M10x1.5 M10x1.25 M10x1.0	M11x1.5 M11x1.25 M11x1.0	UNC7/16x14 UNF7/16x20	BSW7/16x14 BSF7/16x18	G1/8x28 NPT1/8x27	Harley7/16x16 BSC7/16x26 BSB7/16x26	100
<b>BZ012</b>	M12x1.75 M12x1.5 M12x1.25	M12x1.0	UNC1/2x13 UNF1/2x20	BSW1/2x12 BSF1/2x16	G1/4x19	BSC1/2x26 BSB1/2x26	100

# INSTALLATION TOOLS

เครื่องมือในการติดตั้ง



ด้ามถอดสปริงเสริมเกลียว  
**Extracting Tools**



Order No.	M	UNC UNF	BSW BSF		
<b>B7051</b>	M2-M4	UNC2x56 - UNC8x32 UNF2x64 - UNF8x36	BSW1/8	BA3 - BA6	
<b>B7052</b>	M3-M10	UNC4x40 - UNC3/8 UNF4x48 - UNF3/8	BSW3/16 - BSW3/8 BSF3/16 - BSF3/8	BA0 - BA2 G1/8 BSB1/4x26 - BSB3/8x26 BSC5/16x26 - BSC3/8x26	NPT 1/8x27 UNEF1/4x32 Harley1/4x24
<b>B7053</b>	M11-M24	UNC3/8 - UNC1" UNF3/8 - UNF1" UNF1"x14	BSW3/8 - BSW1" BSF3/8 - BSF1"	G1/4x19 - G5/8x14 BSB3/8x26 - BSB1/2x26 BSC3/8x26 - BSC1/2x26 NPT1/4x19 - NPT1/2x14	Harley7/16x16 Cummins11/16x16 Carburetor7/8x20 Carburetor1"x20
<b>B7054</b>	M20-M39	UNC1.1/8" - UNC1.1/2" UNF1.1/8" - UNF1.1/8"	BSW1.1/8" - BSW1.1/2" BSF1.1/8" - BSF1.1/2"	G1/2 - G1" NPT1/2 - NPT1"	UN1.1/8" - UN1.1/2"
<b>B7055</b>	M38-M65				UN1.5/8" - UN2"